

CENTRALE LUBRIFICAZIONE CINEMATICA
LUBRICATION CONTROL UNIT

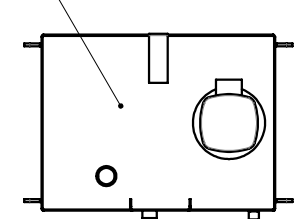

FRIGO OLIO
OIL CHILLER

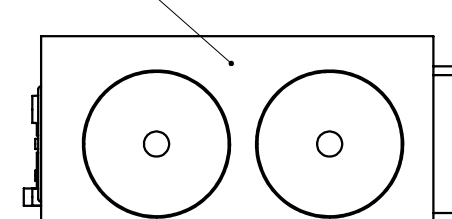

ARMADIO ELETTRICO
ELECTRIC CABINET

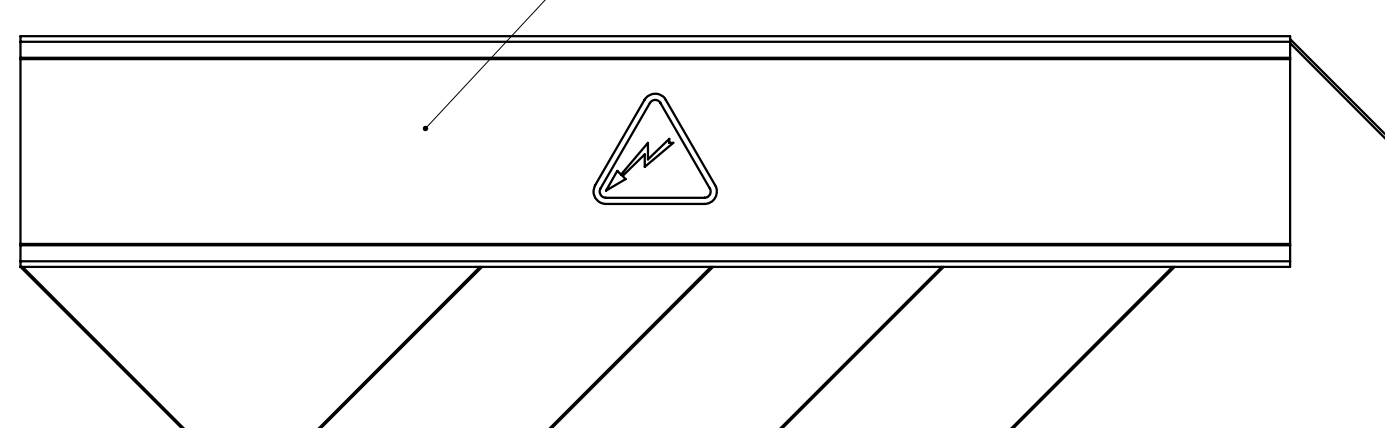

VASCA REFRIGERANTE
TOOL COOLANT UNIT

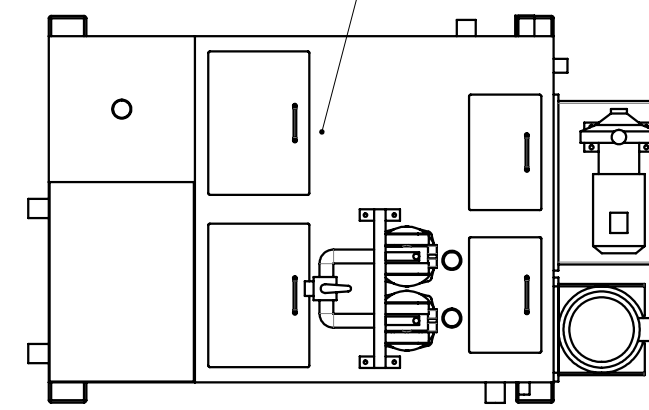

CENTRALE IDROSTATICA/SERVIZI
(HYDROSTATIC/SERVICE UNIT)

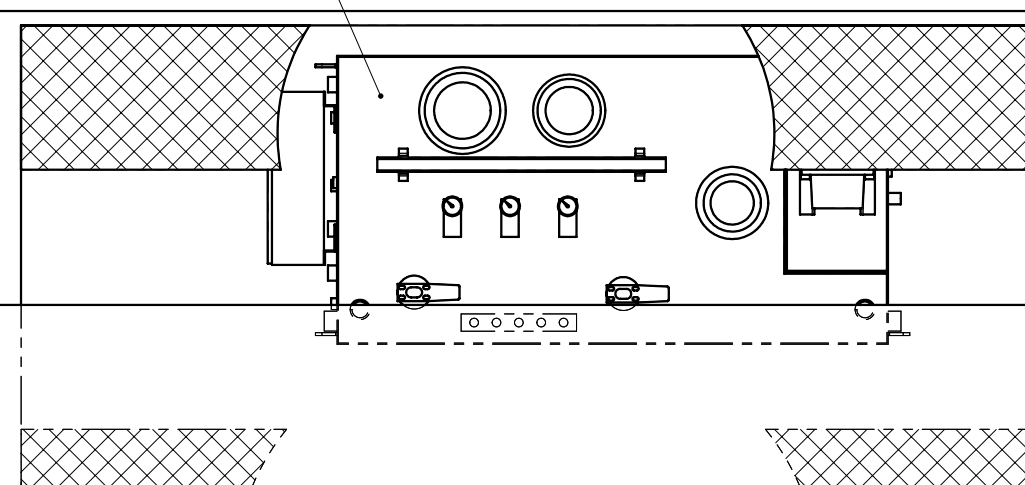

PULSANTIERA MAGAZZINO UTENSILI
TOOL MAGAZINE CONTROL PANEL

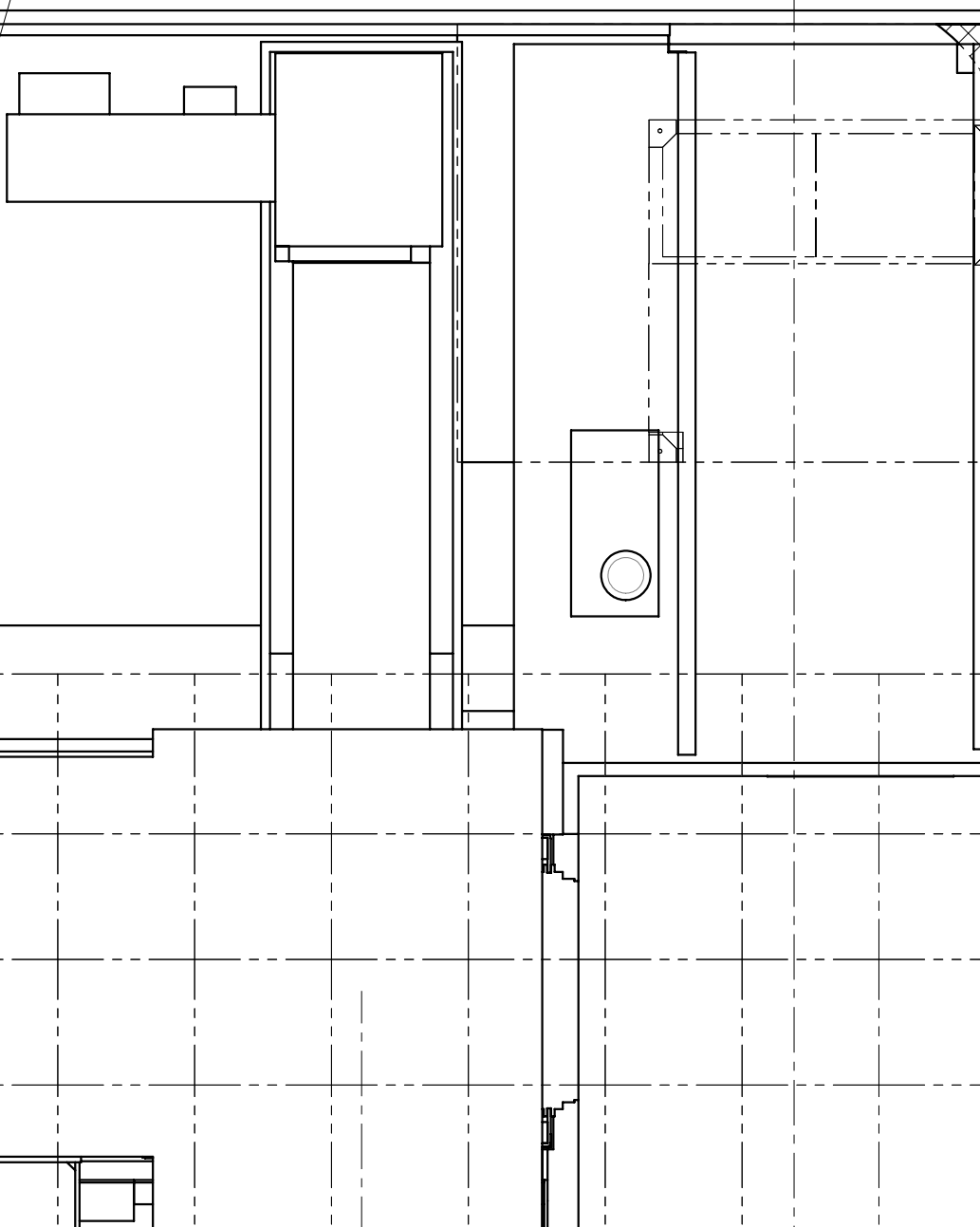

VASCA RECUPERO REFRIGERANTE
TOOL COOLANT UNIT

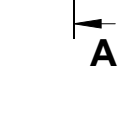
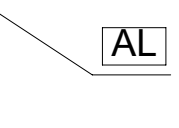
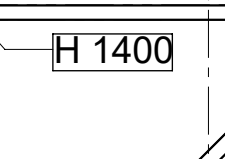
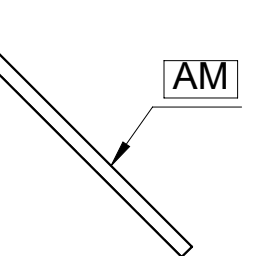
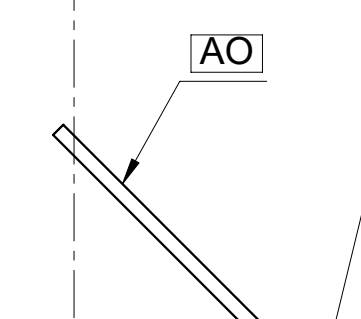
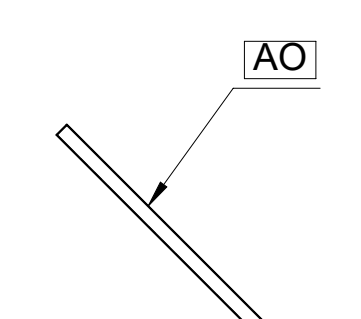
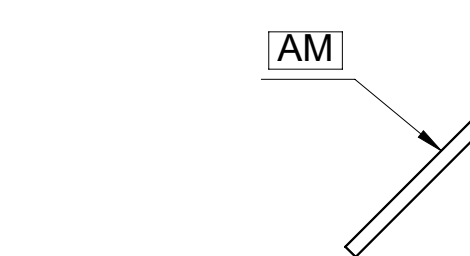
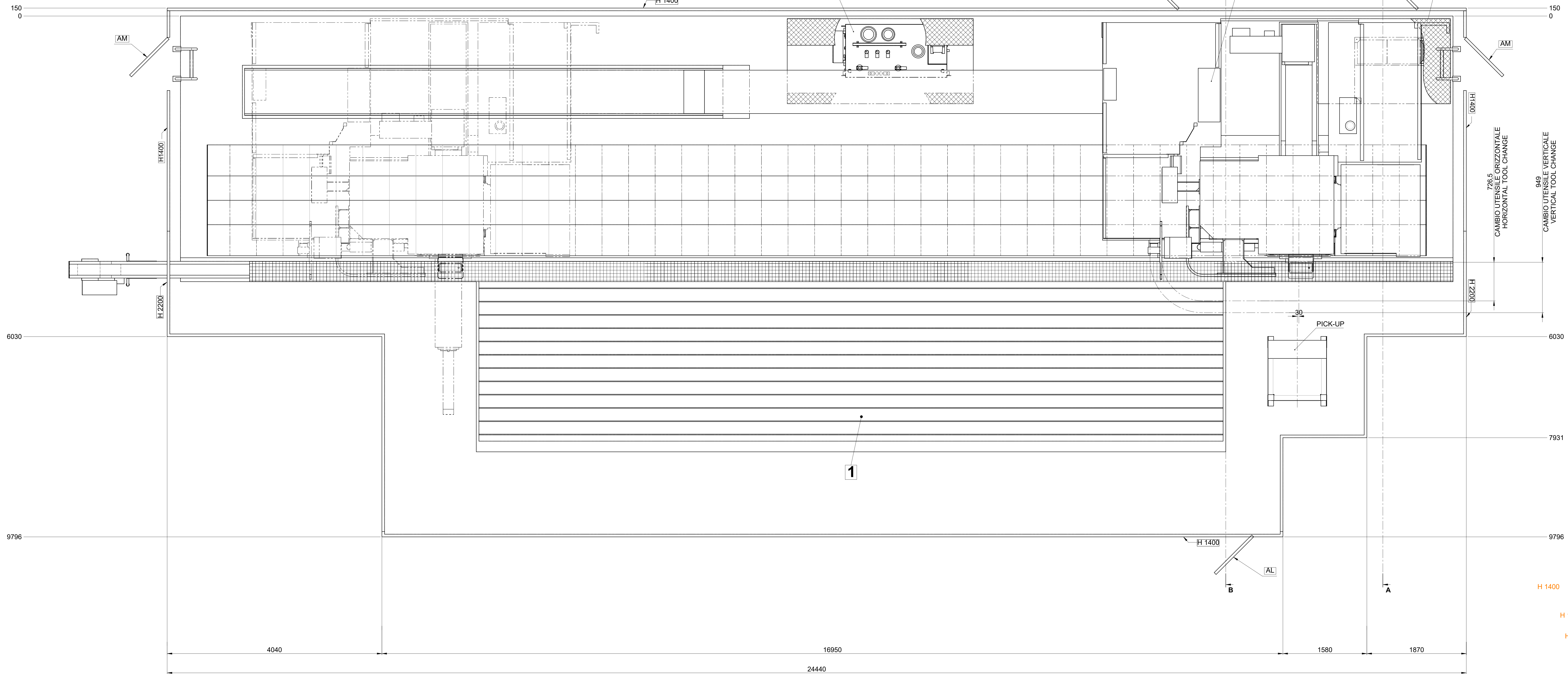
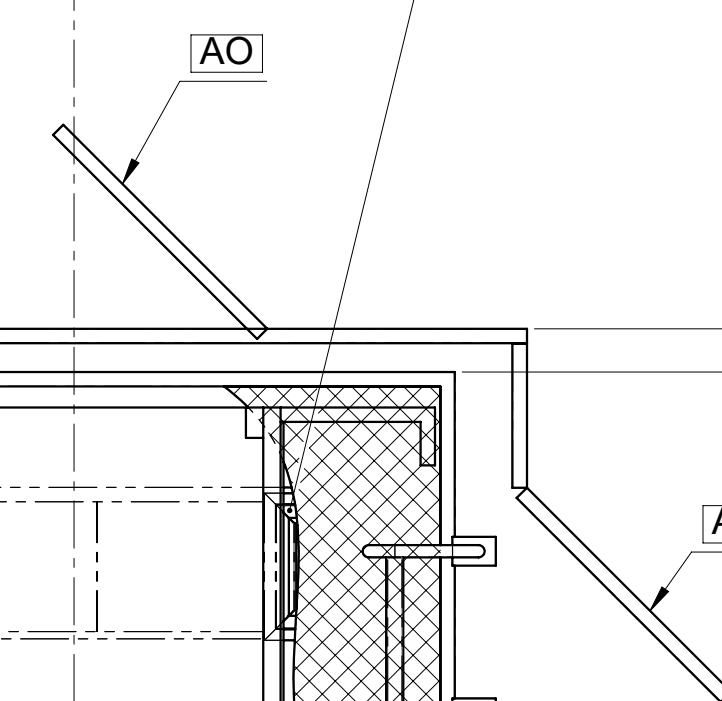

H 1400

H 1400

H 1400

PORTE DI ACCESSO ALL'IMPIANTO / ACCESS DOORS

AO	ACCESSO OPERATORE / OPERATOR ACCESS
AL	ACCESSO AREA LAVORO / WORKING AREA ACCESS
AM	ACCESSO MANUTENZIONE / MAINTENANCE ACCESS

ELENCO ELEMENTI FRONTALI / HEAD-ON ELEMENTS

N°	TIPOLOGIA / TYPE	DIMENSIONI / DIMENSIONS	CORSA V / V STROKE	CARICO / LOAD
1	PIANO FISSO / FLOOR PLATE	14000X3000	-	15000 kg/m ²

GRIGLIATI IN FONDAZIONE A CURA E CARICO DEL CLIENTE
METALLIC COVER AT CUSTOMER'S CHARGE AND CARE

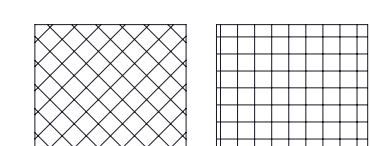

PRELIMINARE/PRELIMINARY

Area manager (Italiano) 2024-12-09

TS-260102

LAY-OUT SPEEDRAM 3000 -

SR-S148GB-12s-14

TS-260102-002-X

1/3

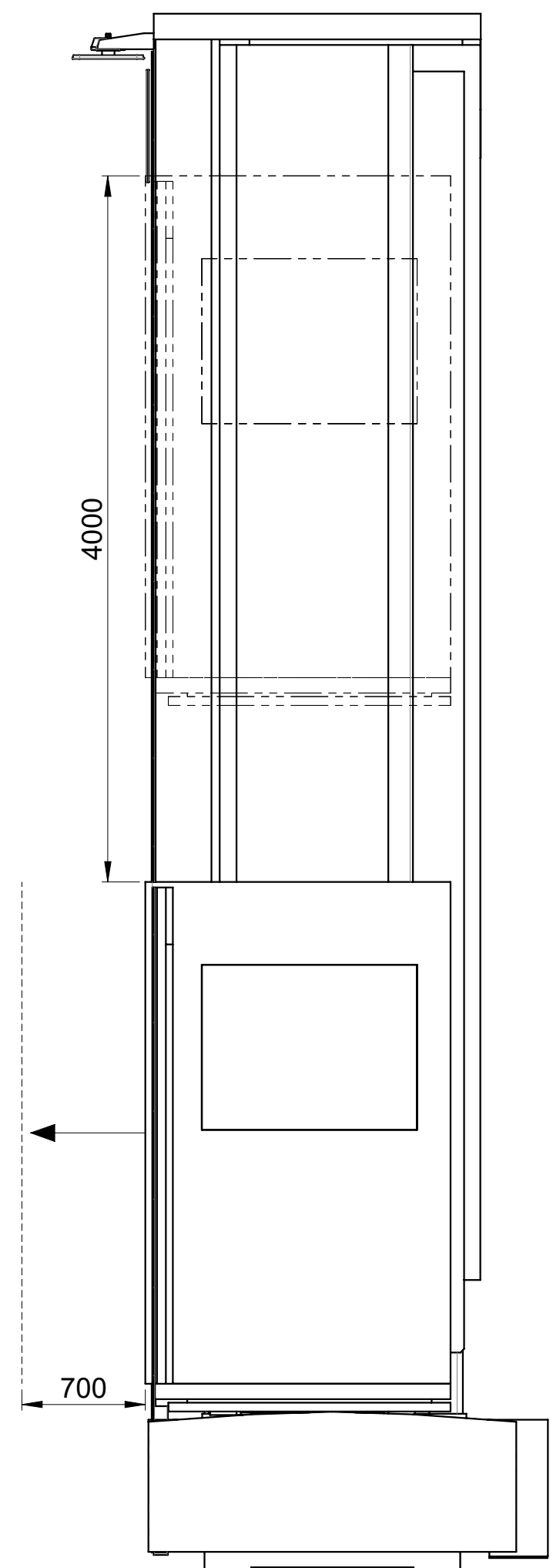

**CORSE PEDANA OPERATORE
OPERATOR PLATFORM'S STROKES**

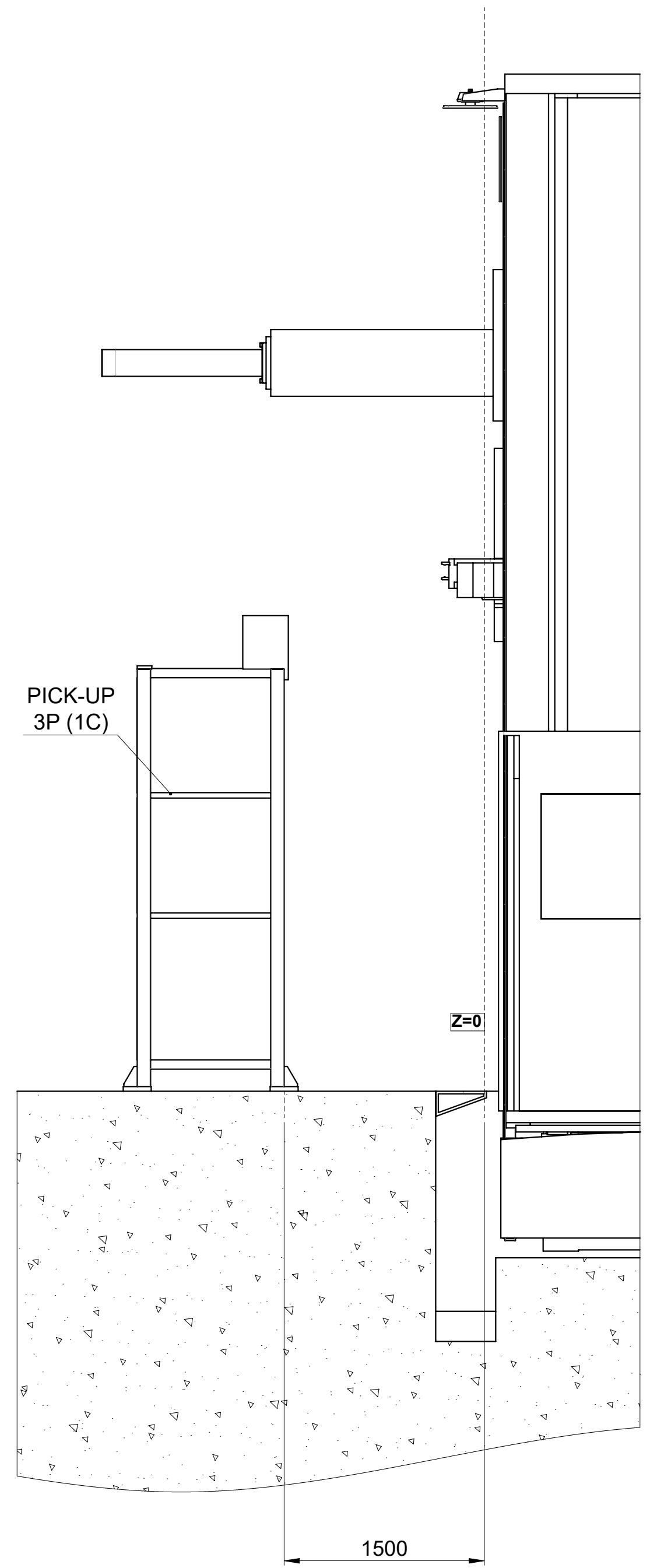
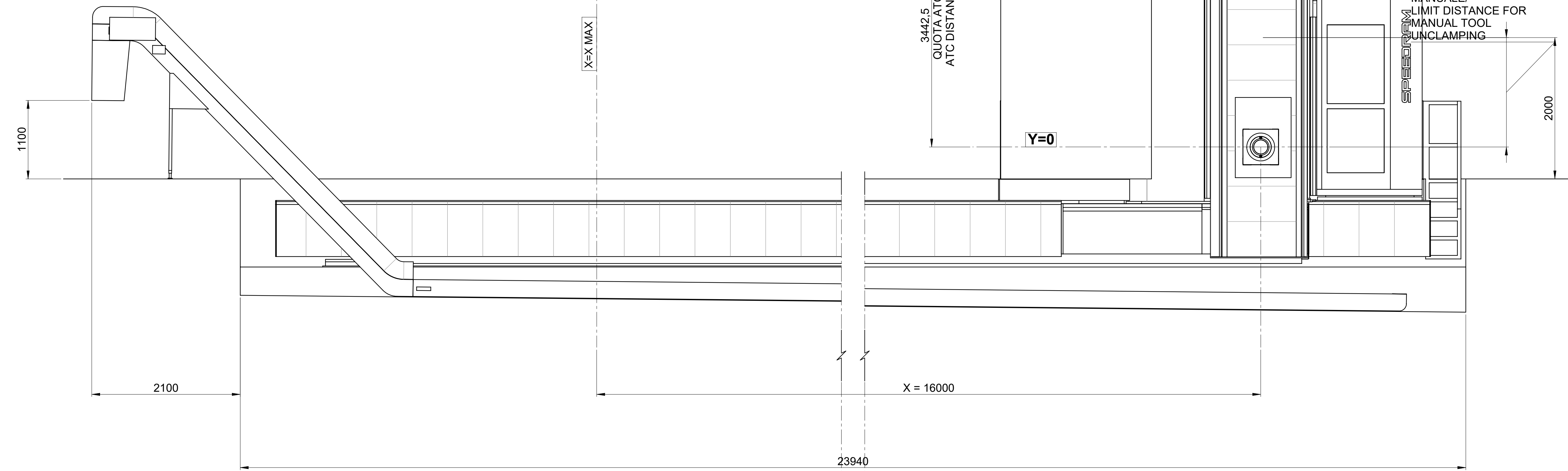

**A-A
270°**

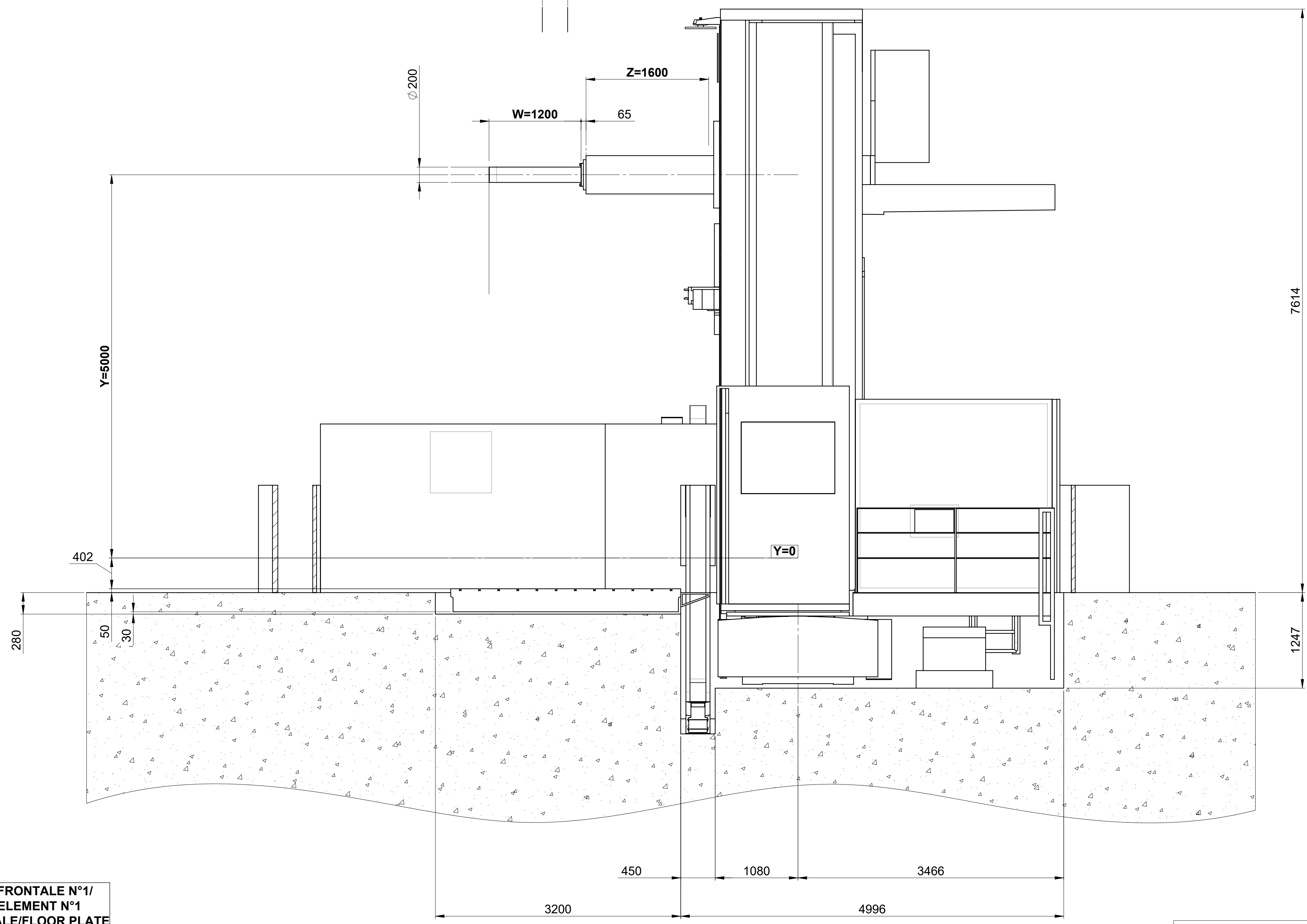



**B-B
270°**

**ELEMENTO FRONTALE N°1/
HEAD-ON ELEMENT N°1
PIANO FRONTALE/FLOOR PLATE
14000X3000**

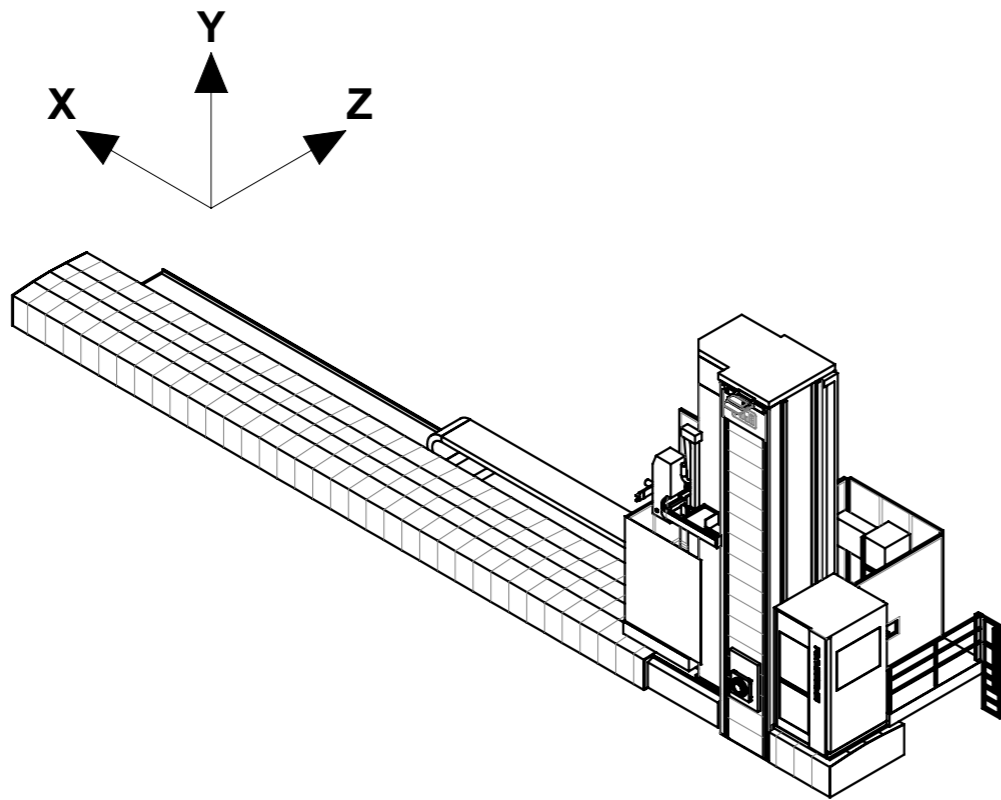
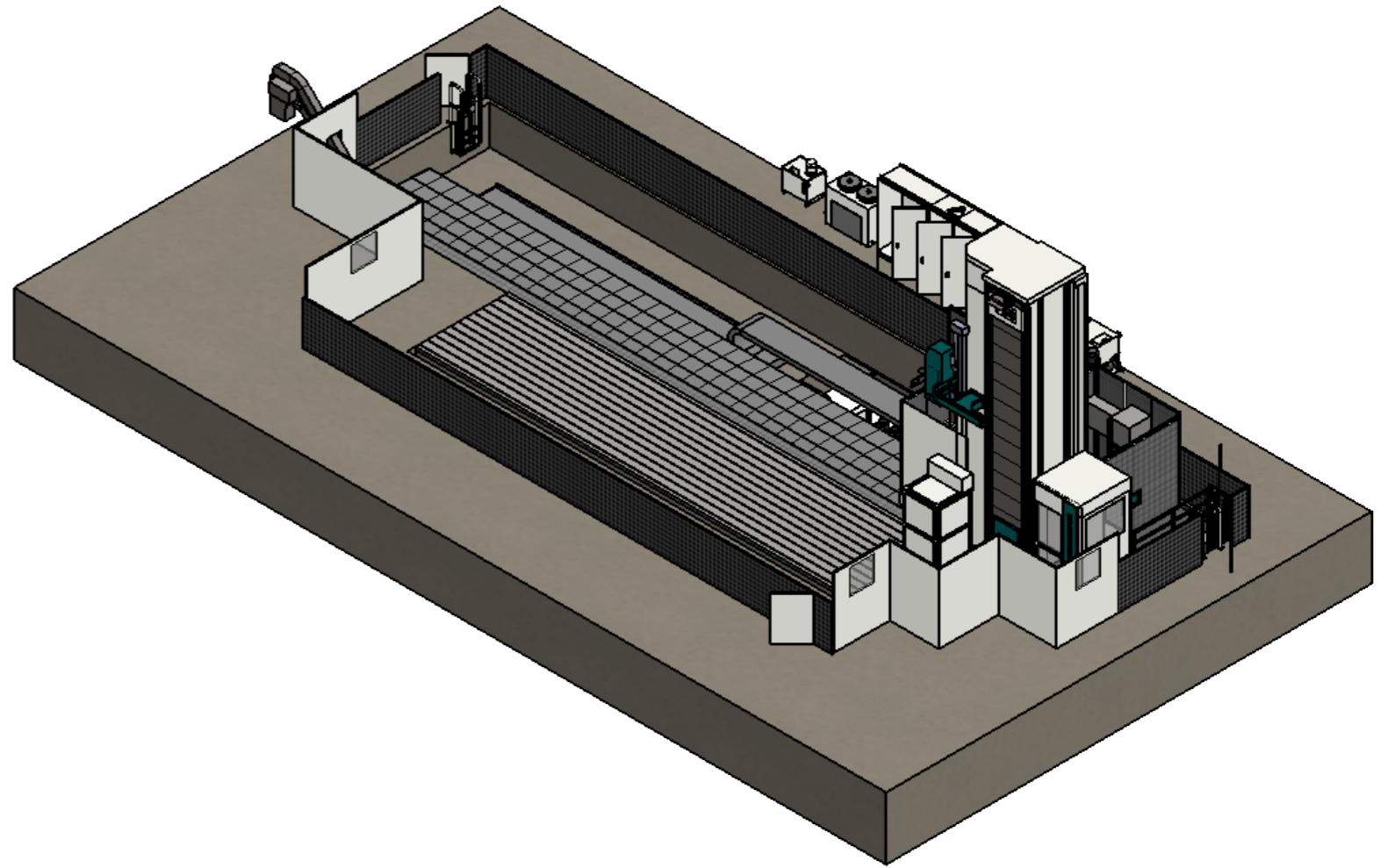
PRELIMINARE/PRELIMINARY		X	Area manager (Italiano)	2024-12-09
Rev.			Disegnato/Drawn	Data/Date
LAY-OUT SPEEDRAM 3000 -		TS-260102		
SR-S148GB-12s-14		TS-260102-002-X		2/3
PAMA		www.pama.it		



PRELIMINARE/PRELIMINARY		X	Area manager (Italiano)	2024-12-09
		Rev.	Disegnato/Drawn	Data/Date
 www.pama.it <small>SW - PAMA Sales Layout REV. X - 24/05/2016</small>	LAY-OUT SPEEDRAM 3000 -		Rif./Ref.	Offerta/Offer
	--	--	Codice macchina/Machine code	TS-260102
	--	--	SR-516BGB-12s-14	 Tipo/Type
			Disegno No./Drawing No.	Foglio/Sheet
			TS-260102-002-X	3/3

Il presente disegno è di proprietà esclusiva della ditta PAMA S.P.A. la quale ne vieta la duplicazione e/o riproduzione e/o copia in qualsiasi forma e con qualsiasi mezzo. La trasmissione del presente disegno non costituisce alcun implicito riconoscimento e/o trasferimento di qualsivoglia diritto sul disegno da parte di PAMA S.P.A. in favore dei soggetti riceventi. Le informazioni e/o i dati contenuti e/o comunque appresi direttamente o indirettamente dal presente disegno non potranno essere divulgati, rivelati, né comunicati a soggetti terzi e dovranno essere trattati dai soggetti detentori come informazioni segrete, ai sensi dell'art. 98 C.P. I. e in conformità a quanto regolato negli specifici accordi di riservatezza che si intendono integralmente richiamati.